

REV 6

QUIET CEILING DESIGN HIGH LUMEN RECESSED DOWNLIGHT

Housing

Aperture : Ø6.3" | Oversize Trim : 7.2" | Ceiling Cutout : 6.7"
Maximum Ceiling Thickness : 2" | Height : 8" | Weight : 13.22 lbs

Material

Housing : Extruded Aluminum
Reflector : Flow Forming Aluminum

Power Input

40W, 60W, 80W, 100W | 120V, 277V

Lumen Output

3,000 lm (40W), 4,350 lm (60W), 6,200 lm (80W), 7,600 lm (100W)

Dimming

Superior 0-10V : Dims to 1%
DMX : High resolution dims to 0.1%

Color Quality

CRI 85+

Rated Life

> 60,000 Hours (L70)

Finish



Black



White

Color Temperature



ColorFlip™ Warm Dim
1900K ↔ 3000K

Optics



40°



60°



Wide

Warranty

5 Year limited warranty

Listing



SPECIFICATION SHEET NEW CONSTRUCTION - WARM DIM

Precision Engineered For High Performance.

6-inch aperture high lumen recessed downlight utilizing Meteor Lighting's proprietary ColorFlip™ Warm Dim solution, that results in superior efficacy and heat management.

This product is compatible with all existing 0-10V and DMX control systems. Bringing ambient lighting to your spaces.

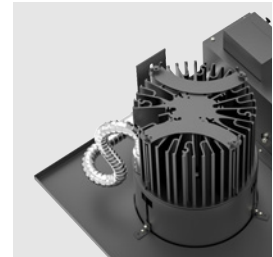
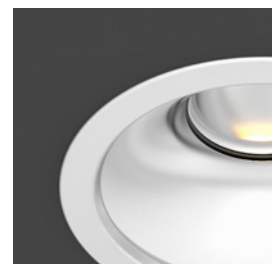
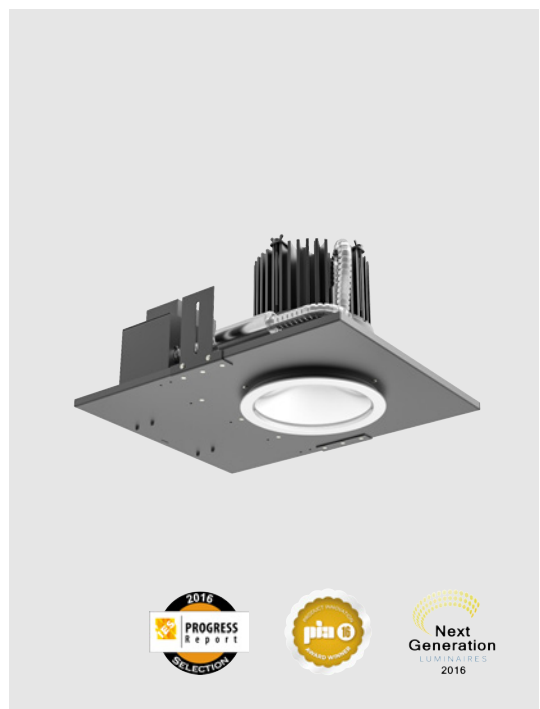

METEOR

meteor-lighting.com

SPECIFICATION

PROJECT NAME

DATE

CATALOG #

QUANTITY

RS6N	MODEL	REV 6 WITH NEW CONSTRUCTION FRAME		
	WATTAGE	40 40W 100 100W	60 60W	80 80W
WDIM	CCT / CRI	WDIM 1900K-3000K		
	VOLTAGE	120 120V	277 277V	
	DIMMING	SPV Superior 0-10V dims to 1%	DMX DMX dims to 0.1% (XLR Sockets)	DMX(RJ45) DMX dims to 0.1% (RJ45 Sockets)
	BEAM ANGLE	40 40°	60 60°	WD ¹ Wide
	FINISH ²	BLK Black	WHT White	SSR ⁴ Semi-Specular Reflector
	ACCESSORIES	SPD ³ Surge Protector	DF ¹ Diffuser	SCA610 Sloped Ceiling Adapter 8°-12°
		SCA615 Sloped Ceiling Adapter 13°-17°	SCA620 Sloped Ceiling Adapter 18°-22°	SCA625 Sloped Ceiling Adapter 23°- 27°
		BUB Butterfly Bracket		

¹ Please factor in change in lumen output with diffuser (-20% with WD; -12% with other degrees).
² Finish indicates Trim only, with standard matte silver reflector.
³ Surge protector for up to 10KV. Applicable for unstable mains or facilities using high-power machinery.
⁴ Option is not compatible with WD, SCA610, SCA615, SCA620, SCA625

TECHNICAL DETAILS

Electrical

- 3,000 lm (40W)
- 4,350 lm (60W)
- 6,200 lm (80W)
- 7,600 lm (100W)
- Power Input: 120V or 277V
- Operating Temperature: -20°F~112°F
- Surge Protection: Built-in is 4KV
- Power Factor Greater than 0.9

LED Features

- ColorFlip™ Warm Dim 1900K ↔ 3000K
- CRI 85+
- Long lasting LED luminaire tested under TM21 lumen maintenance L70 @ 60,000 Hrs

Optics

- Flow Forming Aluminum Reflector
- Beam Angle : 40°, 60°, Wide (With diffuser)

Advanced Dimming

- Proprietary VX Driver™ is incorporated to all dimming options for video flicker-free lighting
- Superior 0-10V : Dims to 1%
- DMX : High resolution dims to 0.1% (Supports ANSI E1.20 RDM protocol)

New Construction Housing

- Aperture : Ø6.3"
- Height : 8"
- Weight : 13.22 lbs
- Material : Extruded Aluminum
- Non-IC Rated, insulation must be kept >1ft from housing
- Oversize Trim : 7.2"
- Ceiling Cutout : 6.7"
- Maximum Ceiling Thickness : 2"
- Tool-less top access allows service from above and below
- Light engine, optics, and driver(s) accessible from below ceiling

*Note: C-Channel / Mounting Channels / T-Bar Hangers are purchased from a third party

Warranty

- 5-year limited warranty

Listing

- ETL Damp Location Listed
- FCC
- UKCA

PERFORMANCE SUMMARY*

Warm Dim	1900K					3000K
DMX CCT Signal (%)	7%	20%	40%	60%	80%	100%
0-10V CCT Voltage	0.7	2	4	6	8	10
40W	60lm	270lm	810lm	1,530lm	2,310lm	3,000lm
60W	90lm	390lm	1,175lm	2,220lm	3,350lm	4,950lm
80W	125lm	560lm	1,675lm	3,160lm	4,775lm	6,200lm
100W	150lm	6,85lm	2,050lm	3,875lm	5,850lm	7,600lm

*Beam Angle: 40° *Tolerance ±8%

PHOTOMETRICS

Below is a typical photometric representation of the Rev 6 fixture. Please download IES files to ensure exact photometric value.

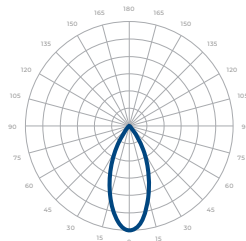

40°

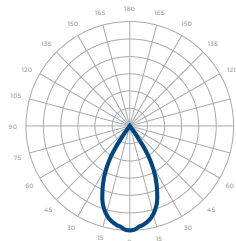

60°

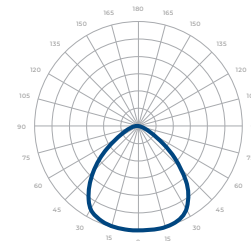

WIDE

DMX REQUIREMENTS

The Rev 6 fixture with DMX is a **single channel dmx** unit that dims both intensity and color temperature between 1900K <-> 3000K. When placing an order, please indicate DMX address. (The DMX address will be listed on the back of the fixture). Do not connect more than 32 fixtures per DMX daisy chain.

The fixture can be connected with RJ45 or XLR sockets. DMX cables **are not** included; please refer to compatible DMX cabling list for more information. The final fixture on each daisy chain should be terminated by the use of a DMX terminator purchased from a 3rd party or from Meteor.

CONNECTION	RJ45 (CAT5e)	5-PIN XLR
Common	WHITE/BROWN(PIN7) & BROWN (PIN 8)	PIN 1
Signal -	ORANGE (PIN 2)	PIN 2
Signal +	WHITE/ORANGE (PIN 1)	PIN 3
Spare	-	PIN 4
Spare	-	PIN 5

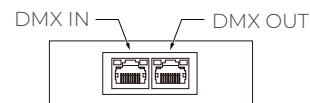

RJ45 Sockets



XLR Sockets

COMPATIBLE DMX CABLING LIST

DMX uses a cable consisting of two twisted pairs plus a shield to carry data. The cable must be specifically impedance matched for the digital DMX signal, meaning that microphone cable or other non-rated cable **must not be used to carry DMX**. Network cable (Cat5, 5e or 6 cable) may be used to carry DMX in an installation; however special consideration must be given to shielding and termination. Under no circumstances should solid core cable like Cat5 be terminated into a screw down connector.

Meteor recommends the use of Belden 9729 or Belden 9841 for DMX installation. Belden 9729/9841 is a two pair cable, which allows for a spare pair for 'out and back' type terminations if needed.

DIMENSIONS

