

# DUO 4 MINI

## ELEGANT 4 INCH UP AND DOWN LUMINAIRE

### Housing

Diameter : Ø4.8" | Height : 9" | Weight : 7.5 lbs

### Material

Housing: High Pressure Die-Cast Aluminum

Lens: Clear polycarbonate

### Power Input

30W | 120-277V

### Lumen Output

2,500 lm (30W) Uplight: 15W / Downlight: 15W

### Dimming

DMX: High resolution dims to 0.1% (Supports ANSI E1.20 RDM protocol)

Superior 0-10V: Dims to 1%

TRC: Linear line-voltage phase control, dims to 1%

LDE1: Hi-Lume 1% EcoSystem LED Driver with Soft-on, Fade-to-Black

### Color Quality

CRI 85, CRI 93 | UGR ≤ 19

### Rated Life

> 60,000 Hours (L70)

### Finish



Black



White

### Color Temperature



2700K



3000K



3500K



4000K

### Optics



15°  
DOWN



25°  
DOWN



35°  
UP/DOWN



60°  
UP/DOWN



WIDE  
UP/DOWN

### Mounting



Power Line



Power Line  
Remote Power

### Warranty

5 Year limited warranty

### Listing



## Revolutionary Mounting System

Perfect for highlighting beautiful ceiling spaces, the embedded Powerline™ System offers a highly aesthetic fixture, with a less than 1-inch canopy option for that truly quiet ceiling design.

Available in a range of dimming capabilities including DMX, this added technology does not compromise the look and feel of the luminaire and is done through a hidden signal wire that can also offer separate uplight and downlight dimming controls.

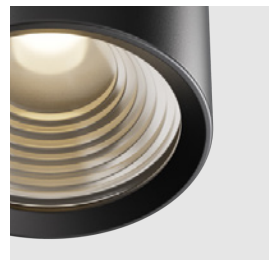
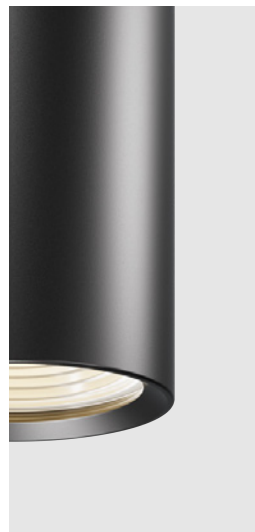

SPECIFICATION SHEET

**DUO 4 MINI** ELEGANT 4 INCH UP AND DOWN LUMINAIRE



**SPECIFICATION**

<b>PROJECT NAME</b>	<b>DATE</b>
<input type="text"/>	<input type="text"/>
<b>CATALOG #</b>	<b>QUANTITY</b>
<input type="text"/>	<input type="text"/>

<b>DUO4M</b>	<b>MODEL</b>	<b>DUO 4 MINI</b>		
<b>30</b>	<b>WATTAGE</b>	<b>30</b> Downlight: 15W Uplight: 15W		
	<b>CCT / CRI</b>	<b>278</b> 2700K / CRI 85 <b>309</b> 3000K / CRI 93	<b>279</b> 2700K / CRI 93 <b>359</b> 3500K / CRI 93	<b>308</b> 3000K / CRI 85 <b>408</b> 4000K / CRI 85
<b>UNV</b>	<b>VOLTAGE</b>	<b>UNV</b> 120 – 277V		
	<b>DIMMING<sup>1</sup></b>	<b>NOD</b> Non-Dimming <b>LDEI</b> Hi-Lume 1% EcoSystem LED Driver with Soft-on, Fade-to-Black	<b>SPVS</b> Superior 0-10V dims to 1% Single (Up/Down Together) <b>DMXR</b> DMX dims to 0.1% (RJ45 Sockets)	<b>TRC</b> Linear line-voltage phase control, dims to 1%
	<b>BEAM ANGLE</b>	<b>Downlight</b>		
		<b>15</b> 15° <b>60</b> 60°	<b>25</b> 25° <b>WD<sup>1</sup></b> Wide	<b>35</b> 35°
		<b>Uplight</b>		
		<b>35</b> 35°	<b>60</b> 60°	<b>WD<sup>1</sup></b> Wide
	<b>FINISH</b>	<b>BLK</b> Black	<b>WHT</b> White	
	<b>MOUNTING</b>	<b>PL2 ( 2 / 4 / 6 / 8 / 10 )</b> Power Line Mount (2, 4, 6, 8, and 10 ft.)	<b>PL2RM ( 2 / 4 / 6 / 8 / 10 )</b> Power Line Mount With Remote Power(2, 4, 6, 8, and 10 ft.)	<b>EMP</b> Remote Emergency Pack

<sup>1</sup> Please factor in change in lumen output of -20% with WD

## SPECIFICATION SHEET

# DUO 4 MINI

ELEGANT 4 INCH  
UP AND DOWN LUMINAIRE



## TECHNICAL DETAILS

### Electrical

- 2,500 lm (30W) Uplight: 15W / Downlight: 15W
- Power Input: Universal (120-277V)
- Operating Temperature: -13°F~104°F
- Surge Protection: Built-in is 2.5KV
- Power Factor Greater than 0.9
- Remote Emergency Pack: Bodine BSL20B2UEK55C111

### LED Features

- Color Temperature: 2700K, 3000K, 3500K, 4000K
- CRI 85, CRI 93
- UGR ≤ 19
- Long lasting LED luminaire tested under TM21 lumen maintenance L70 @ 60,000 Hrs

### Optics

- Precision molded high transmittance clear lenses
- Beam Angle Down: 15°, 25°, 35°, 60°, WD
- Beam Angle Up: 35°, 60°, WD

### Advanced Dimming

- Proprietary VX Driver™ is incorporated to all dimming options for video flicker-free lighting
- DMX: high resolution dims to 0.1% (Supports ANSI E1.20 RDM protocol)
- Superior 0-10V: dims to 1%
- TRC: Linear line-voltage phase control, dims to 1%
- LDE1: Hi-Lume 1% EcoSystem LED Driver with Soft-on, Fade-to-Black

### Housing

- Diameter: Ø4.8"
- Height: 9"
- Material: High Pressure Die-Cast Aluminum
- Weight: 7.5 lbs
- Canopy Height: 2.9"

### Mounting

- Power Line Mount 2ft, 4ft, 6ft, 8ft, 10ft with High Lumen Power Suspension (Canopy Height: 2.95")
- Power Line Mount 2ft, 4ft, 6ft, 8ft, 10ft with High Lumen Power Suspension and Remote Power (Canopy Height: 0.84")

### Warranty

- 5-year limited warranty

### Listing

- ETL Damp Location Listed

## PERFORMANCE SUMMARY\*

Delivered Lumens				
CCT/WATTAGE	2700K	3000K	3500K	4000K
30W UP (15W)	1,110lm	1,160lm	1,195lm	1,250lm
30W DOWN (15W)	1,110lm	1,160lm	1,195lm	1,250lm

Current Consumption		
WATTAGE / VOLT	120V	277V
30W	0.28A	0.12A

\*Tolerance ±8%

SPECIFICATION SHEET

**DUO 4 MINI** ELEGANT 4 INCH  
UP AND DOWN LUMINAIRE



**PHOTOMETRICS**

Below is a typical photometric representation of the Duo 4 fixture. Please download IES files to ensure exact photometric value.

Downlight:

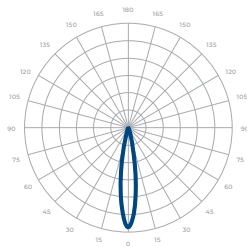

15°

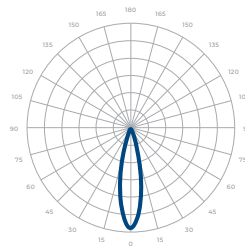

25°

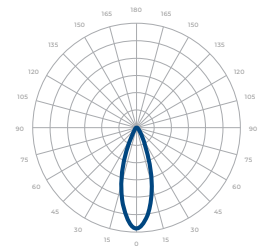

35°

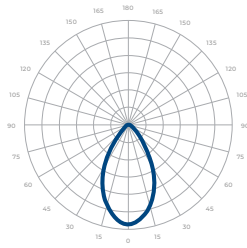

60°

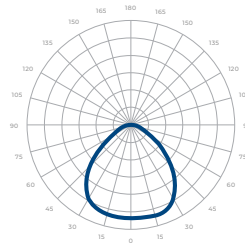

WIDE

Uplight:

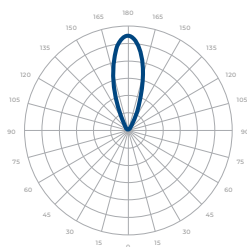

35°

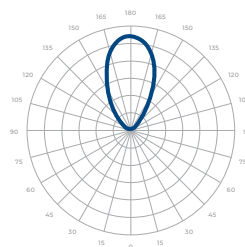

60°

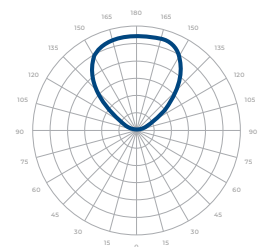

WIDE

### DMX REQUIREMENTS

The Duo 4 Mini fixture with DMX is a **two channel dmx** unit (1 to control uplight, 1 to control downlight).  
 Fixture will be controlled by DMX number controlling intensity. We do not recommend more than 32 fixtures per DMX daisy chain.  
 When placing order, please indicate DMX address (refer to DMX Address example below).  
 DMX address will be listed on the back of each fixture.

DMX Address		
Fixture	Uplight (ex. X)	Downlight (ex. X+1)
#1	1	2
#2	3	4
#3	5	6

The LED fixture provide RJ45 Socket socket to connect. (DMX cable **not** included.)  
 The final fixture should be terminated by the use of DMX Terminator (by others).

CONNECTION	RJ45 (CAT5e)
Common	WHITE/BROWN(PIN7) & BROWN (PIN 8)
Signal -	ORANGE (PIN 2)
Signal +	WHITE/ORANGE (PIN 1)
Spare	-
Spare	-

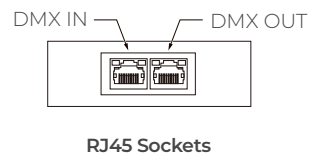

### COMPATIBLE DMX CABLING LIST

DMX uses a cable consisting of two twisted pairs plus a shield to carry data. The cable must be specifically impedance matched for the digital DMX signal, meaning that microphone cable or other non-rated cable **must not be used to carry DMX**. Network cable (Cat5, 5e or 6 cable) may be used to carry DMX in an installation; however special consideration must be given to shielding and termination. Under no circumstances should solid core cable like Cat5 be terminated into a screw down connector.

Meteor recommends the use of Belden 9729 or Belden 9841 for DMX installation. Belden 9729/9841 is a two pair cable, which allows for a spare pair for 'out and back' type terminations if needed.

### COMPATIBLE TRC DIMMER LIST

PART NO.					
Lutron S-603PG	Lutron DVCL-153P	Lutron DVLV-600P	Lutron TGCL-153P	Lutron S-600P	Lutron DVELV-303P
Lutron SELV-300P	Lutron TG-600P	Lutron DVLV-600P	Lutron LG-600P	Lutron CT-103P	Lutron MAELV-600
Lutron FAELV-500	Leviton IPI06-1LZ	Leviton 6631-2	Leviton VPE06	Leviton 6683-IW	Leviton 6161
Leviton 6633-P	Leviton IPE04	Cooper DLC03P	Cooper SLC03P	Cooper DAL06P	Lightolier ZP260QEW

SPECIFICATION SHEET

**DUO 4 MINI** ELEGANT 4 INCH UP AND DOWN LUMINAIRE



**COMPATIBLE Lutron DIMMER LIST**

LUTRON PART NO.						
RMJ-ECO32-DV-B	FCJ/FCJS-ECO	QSN-1ECO-S	QSN-2ECO-S	QSGRJ-_E	QSGR-_E	QP2-_ _ 2C
QP2-_ _ 4C	QP2-_ _ 6C	QP2-_ _ 8C	LQSE-2ECO-D			

**DIMENSIONS**

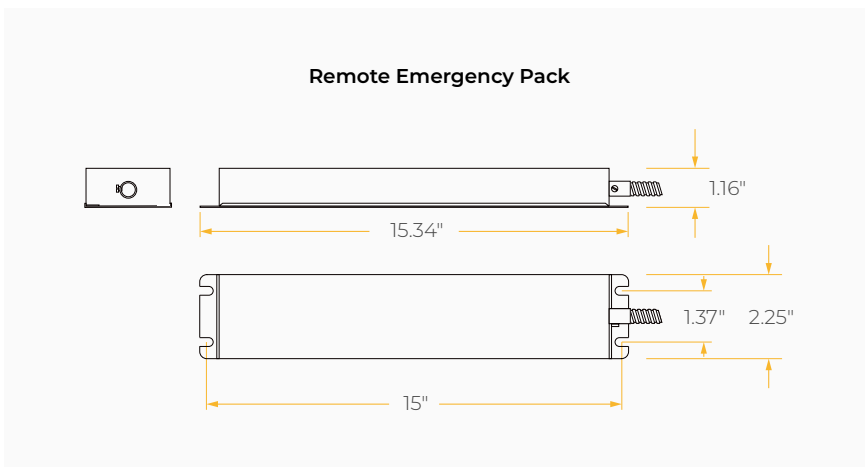
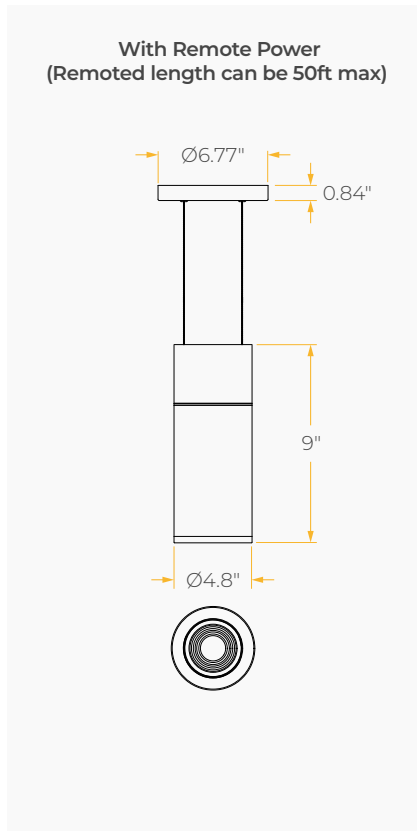
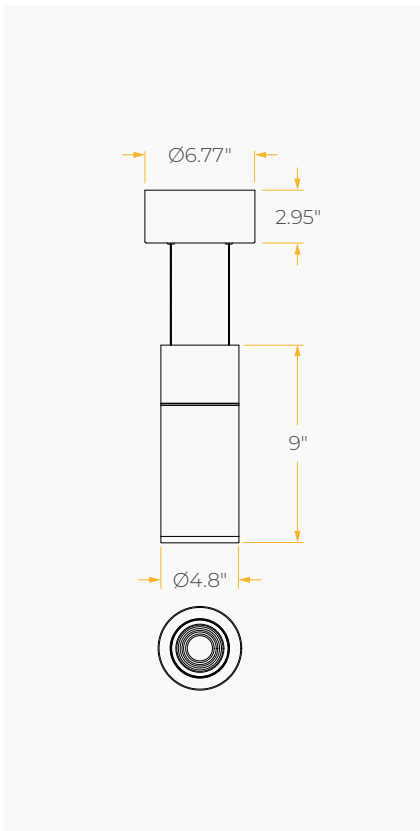

**MOUNTING OPTIONS\***

\*Junction Box not included

