

ATRIA 4

SPECIFICATION SHEET
STANDARD

QUIET CYLINDER WITH PRISMATIC LENS

Housing

Diameter : Ø4.8" | Height : 13" | Weight : 8 lbs

Material

Housing: High Pressure Die-Cast Aluminum
Lens: Clear Polycarbonate

Power Input

15W, 25W, 35W, 45W, 65W | 120-277V

Lumen Output

1,500 lm (15W), 2,205 lm (25W), 2,690 lm (35W), 4,305 lm (45W)
5,650 lm (65W)

Dimming

Standard 0-10V : Dims to 10%
Superior 0-10V : Dims to 1%
DMX : High resolution dims to 0.1%
TRC : Linear line-voltage phase control, dims to 1%
LDE1 : Hi-Lume 1% EcoSystem
DALI : Dims to 10%

Color Quality

CRI 85, CRI 93

Rated Life

> 60,000 Hours (L70)

Finish

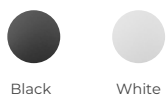

Color Temperature

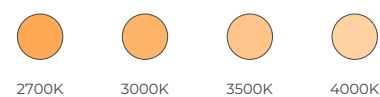

Optics

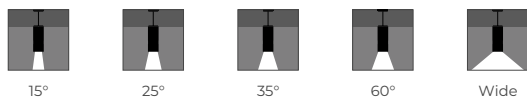

Mounting



Warranty

5 Year limited warranty

Listing



Masterfully engineered and aesthetically refined.

The Atria 4 is a high-performing cylinder for mixed applications. The cylinder is compatible with our ColorFlip™ color-changing technologies, and feature decorative options in the glow ring and mid-lit reveal.

A prismatic lens offers superior light transmission and minimizes glare.

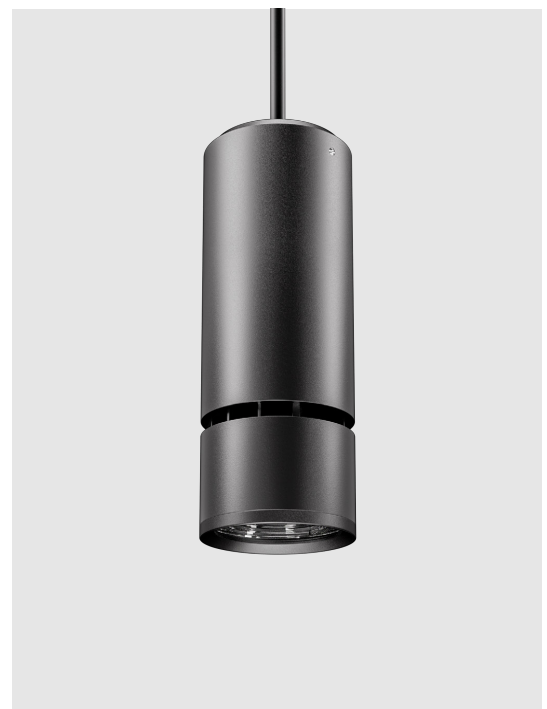

METEOR

meteor-lighting.com

SPECIFICATION SHEET / STANDARD

ATRIA 4 QUIET CYLINDER WITH PRISMATIC LENS



SPECIFICATION

PROJECT NAME	DATE
<input type="text"/>	<input type="text"/>

CATALOG #	QUANTITY
<input type="text"/>	<input type="text"/>

AS4	MODEL	ATRIA 4		
<input type="text"/>	WATTAGE	15 15W 45 45W	25 25W 65 65W	35 35W
<input type="text"/>	CCT / CRI	278 2700K / CRI 85 309 3000K / CRI 93 408 4000K / CRI 85	279 2700K / CRI 93 358 3500K / CRI 85	308 3000K / CRI 85 359 3500K / CRI 93
UNV	VOLTAGE	UNV 120 – 277V		
<input type="text"/>	DIMMING	STV Standard 0-10V dims to 10% DMX(RJ45)¹ DMX dims to 0.1% (RJ45 Sockets) DALI³ DALI dims to 10%	SPV Superior 0-10V dims to 1% TRC² Linear line-voltage phase control, dims to 1%	DMX¹ DMX dims to 0.1% (XLR Sockets) LDE1³ Hi-Lume 1% EcoSystem LED Driver with Soft-on, Fade-to-Black (UNV only)
<input type="text"/>	BEAM ANGLE	15 15° 60 60°	25 25° WD⁴ Wide	35 35°
<input type="text"/>	FINISH	BLK Black	WHT White	
<input type="text"/>	RIM FINISH	STD Standard Trim	GLR Glowing Ring	MLT⁵ Mid-Lit Trim
<input type="text"/>	MOUNTING	SUM Surface Mount AD10 Adjustable Cable 10ft SAD10 Sloped Adjustable Cable 10ft	ST2 Stem 2ft WLM Wall Mount	ST4 Stem 4ft YKM Yoke Mount
<input type="text"/>	ACCESSORIES	NO No Accessories CT⁷ Conduit Mount	EMP Remote Emergency Pack	DF⁶ Diffuser

¹ DMX option not compatible with WLM, 65W
² Option is only compatible with 120V and not compatible with 45W, 65W.
³ Please factor in change in lumen output of -20% with WD
⁴ MLT not compatible with 65W
⁵ Please factor in change in lumen output with diffuser (-20% with WD; -12% with other degrees)
⁶ CT only compatible with ST and AD mounting types

TECHNICAL DETAILS

Electrical

- 1,500 lm (15W), 2,205 lm (25W), 2,690 lm (35W), 4,305 lm (45W), 5,650 lm (65W)
- Power Input: Universal (120-277V)
- Operating Temperature: -13°F~104°F
- Surge Protection: Built-in is 4KV
- Emergency Pack with Mounting Plate: Bodine BSL20B2UEK55C11

LED Features

- Color Temperature: 2700K, 3000K, 3500K, 4000K
- CRI 85, CRI93
- Long lasting LED luminaire tested under TM21 lumen maintenance L70 @ 100,000 Hrs
- Lumen Maintenance > 0.90 at 60,000 hours

Optics

- Precision molded high transmittance clear PC lens
- Beam Angle: 15°, 25°, 35°, 60°, Wide

Advanced Dimming

- Proprietary VX Driver™ is incorporated to all dimming options for video flicker-free lighting
- Standard 0-10V: Dims to 10%
- Superior 0-10V: Dims to 1%
- DMX: High resolution dims to 0.1% (Supports ANSI E1.20 RDM protocol)
- TRC: Linear line-voltage phase control, dims to 1% (120V only)
- LDEI: Hi-Lume 1% EcoSystem LED Driver with Soft-on, Fade-to-Black (UNV only)
- DALI: Dims to 10%

Housing

- Diameter: Ø4.8"
- Height: 12.6"
- Material: High Pressure Die-Cast Aluminum, PC Lens
- Weight: 8 lbs

Mounting

- Surface Mount
- Stem 2ft or 4ft; 45° Swivel Canopy Included
- Adjustable Cable 10ft
- Sloped Adjustable Aircraft Cable 10ft
- Yoke Mount
- Wall Mount

Warranty

- 5-year limited warranty

Listing

- ETL Wet Location Listed
- CE
- FCC
- Energy Star Rated

PERFORMANCE SUMMARY*

Delivered Lumens				
CCT/WATTAGE	2700K	3000K	3500K	4000K
15W	1,340lm	1,380lm	1,460lm	1,500lm
25W	1,990lm	2,060lm	2,180lm	2,205lm
35W	2,400lm	2,480lm	2,620lm	2,690lm
45W	3,720lm	3,980lm	4,210lm	4,305lm
65W	5,120lm	5,280lm	5,590lm	5,650lm

Current Consumption		
WATTAGE / VOLT	120V	277V
15W	0.17A	0.08A
25W	0.23A	0.11A
35W	0.34A	0.15A
45W	0.45A	0.2A
65W	0.64A	0.29A

*Beam Angle: 25° * Tolerance ±8%

Emergency Pack Lumen Output Table				
CCT	2700K	3000K	4000K	5000K
LUMEN	1,640lm	1,760lm	1,890lm	1,950lm

PHOTOMETRICS

Below is a typical photometric representation of the Atria 4 fixture. Please download IES files to ensure exact photometric value.

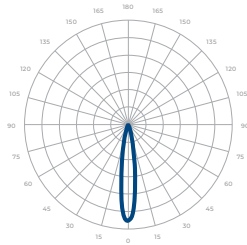

15°

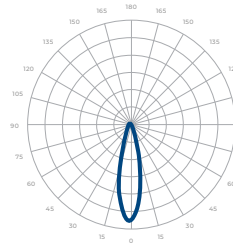

25°

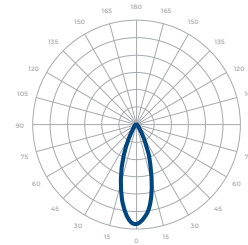

35°

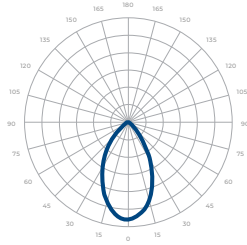

60°

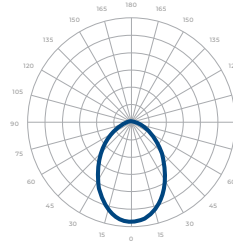

Wide

DMX REQUIREMENTS

The Atria 4 LED fixture with DMX is a **single channel dmx** unit.

When placing an order, please indicate DMX address. (The DMX address will be listed on the back of the fixture.)

The LED fixture provides RJ45 socket or XLR socket to connect. (DMX cable **not** included.)

The final fixture should be terminated by the use of a DMX terminator (by others).

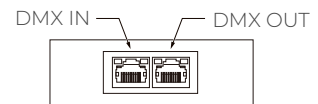

RJ45 Sockets



DMX IN DMX OUT

XLR Sockets

CONNECTION	RJ45 (CAT5e)	5-PIN XLR
Common	WHITE/BROWN(PIN7) & BROWN (PIN 8)	PIN 1
Signal -	ORANGE (PIN 2)	PIN 2
Signal +	WHITE/ORANGE (PIN 1)	PIN 3
Spare	-	PIN 4
Spare	-	PIN 5

COMPATIBLE DMX CABLING LIST

DMX uses a cable consisting of two twisted pairs plus a shield to carry data. The cable must be specifically impedance matched for the digital DMX signal, meaning that microphone cable or other non-rated cable **must not be used to carry DMX**. Network cable (Cat5, 5e or 6 cable) may be used to carry DMX in an installation; however special consideration must be given to shielding and termination. Under no circumstances should solid core cable like Cat5 be terminated into a screw down connector.

Meteor recommends the use of Belden 9729 or Belden 9841 for DMX installation. Belden 9729/9841 is a two pair cable, which allows for a spare pair for 'out and back' type terminations if needed.

COMPATIBLE LDE1 DIMMER LIST

LUTRON PART NO.						
RMJ-ECO32-DV-B	FCJ/FCJS-ECO	QSN-1ECO-S	QSN-2ECO-S	QSGRJ-_E	QSGR-_E	QP2-__2C
QP2-__4C	QP2-__6C	QP2-__8C	LQSE-2ECO-D			

COMPATIBLE TRC DIMMER LIST

PART NO.					
Lutron S-603PG	Lutron DVCL-153P	Lutron DVLV-600P	Lutron TGCL-153P	Lutron S-600P	Lutron DVELV-303P
Lutron SELV-300P	Lutron TG-600P	Lutron DVLV-600P	Lutron LG-600P	Lutron CT-103P	Lutron MAELV-600
Lutron FAELV-500	Leviton IPI06-1LZ	Leviton 6631-2	Leviton VPE06	Leviton 6683-IW	Leviton 6161
Leviton 6633-P	Leviton IPE04	Cooper DLC03P	Cooper SLC03P	Cooper DAL06P	Lightolier ZP260QEW

RIM FINISH

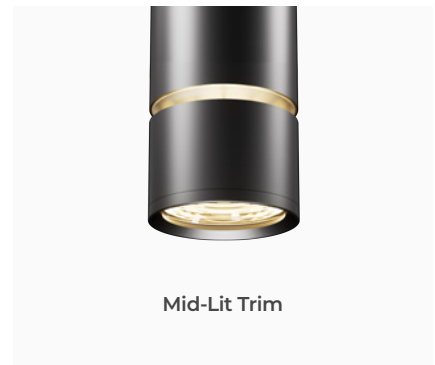
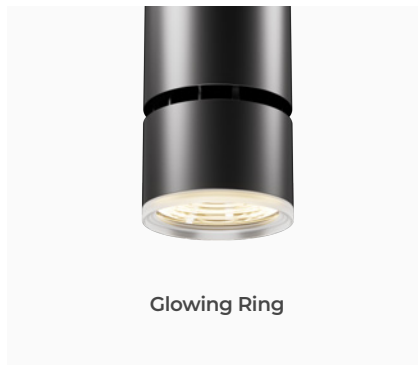
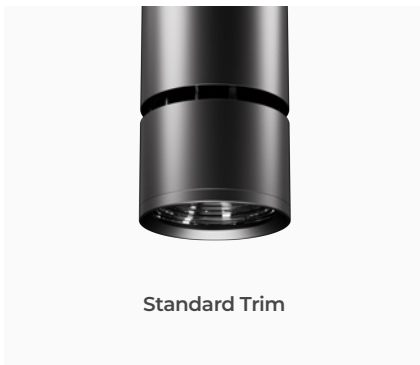

DIMENSIONS

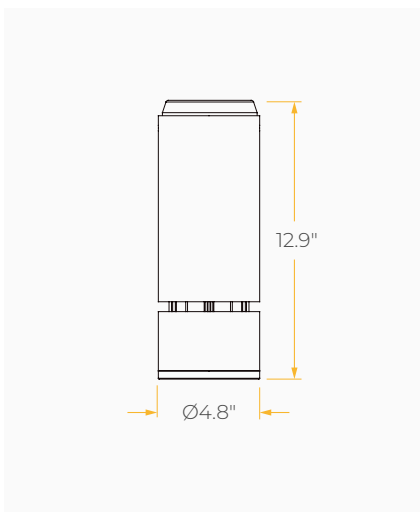

DIMENSIONS

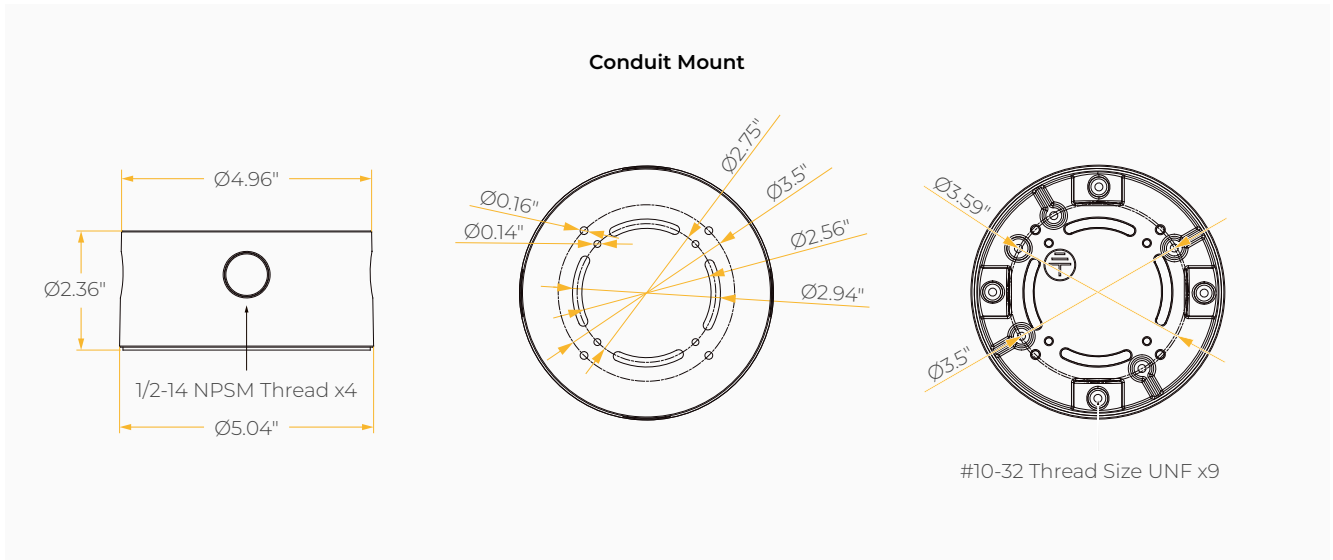
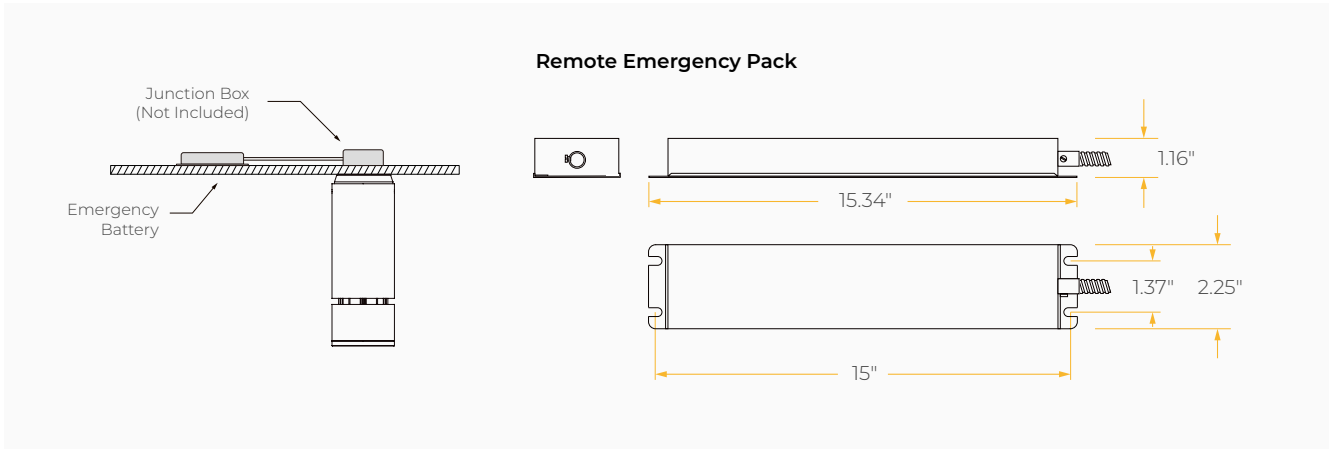

MOUNTING OPTIONS*

*Junction box not included

